

ASSEMBLY PARTS SHEET

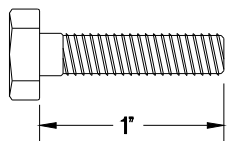

**1/4" x 1" #20
HEX HEAD CAP SCREW**

USE IN CONJUNCTION WITH NUT AND WASHER TO ASSEMBLE SHROUD.

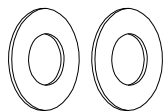

1/4" WASHER



1/4" NUT

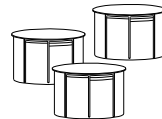

1/2" PLASTIC HOLE PLUGS. USE TO CAP ACCESS HOLES FOR CAM WRENCH.
NOTE: IF PLUG IS LOOSE, PLACE SMALL AMOUNT OF SILICONE INSIDE OF RIM AND PUSH INTO PLACE

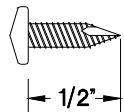

**1/2" x #6
SELF-STARTING SHEET METAL SCREW**

USE TO SECURE TRIM AND ANCHORS TO WALLS.

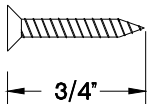

**3/4" x #6
PAN HEAD SCREW**

USE TO SECURE SHELF STANDARDS TO PARTITION WALL

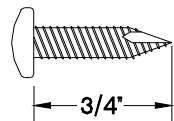

**3/4" x #10
SELF-STARTING SHEET METAL SCREW**

USE TO SECURE HEADER BRACE PIPE AND MEMBRANE ROOFCAP FOR OUTDOOR UNITS.

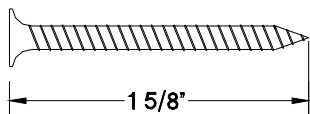

**1 5/8" x #6
WOOD SCREW**

USE TO SECURE PARTITION TO SUPPORT LEG

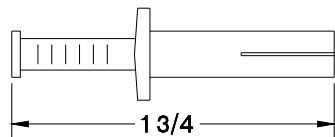

**1/4" x 2 1/4"
HAMMER DRIVE ANCHOR.**

(DRILL 1/4" DIA. HOLE IN CONCRETE BEFORE INSERTING)

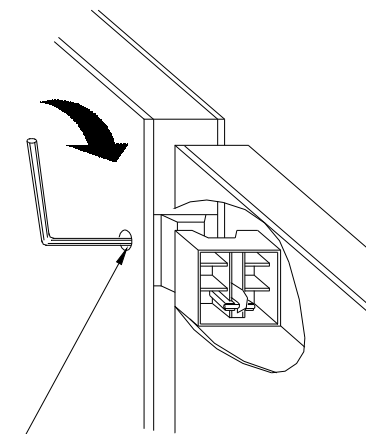

INSERT CAM WRENCH INTO HOLE AND TURN CLOCKWISE TO SECURE PANELS TOGETHER.

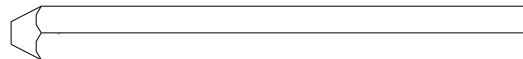

CAM WRENCH. USE TO SECURE INDIVIDUAL PANELS TOGETHER.

6615 Nineteen Mile Road
Sterling Heights MI 48314-2117
PHONE: (800) 521-0398 FAX: (586) 254-0485

SRC REFRIGERATION
Refrigeration Specialists

Please note: Many SRC parts have been shown. Some may not apply to your particular job.