

SRC SERIES III MO# PC612D

STANDARD FEATURES

- INTERIOR VOLUME: 427 CU. FT.
- PREFAB WALL PANELS WITH EASY LOCKING CAMS
- 4" CFC FREE, SOLID FOAM POLYSTYRENE INSULATION
- CHOICE OF FINISHES AS PER SPEC
- FLOORLESS CONSTRUCTION
- 35½" X 78" UL APPROVED ENTRANCE DOOR
W/INT. LIGHT, EXT. SWITCH & DIGITAL THERMOMETER
- DIVIDING WALL WITH 2 GLASS SHELVES PER DOOR
- 30¼" X 67" H GLASS DOORS WITH LIGHTS & FRAME HEAT



- SURROUND AIR REFRIGERATION SYSTEM
- ETHYLENE GAS FILTER - 1ST YEAR PROGRAM INCLUDED

EXTERIOR FINISH: FRONT & SIDE - CIRCLE: LT OR RT
CIRCLE: BLACK, WHITE, ALMOND, GRAY, TAN, SHERWOOD GREEN, SLATE BLUE, SPRUCE GREEN, WALNUT & LIGHT OAK WOODGRAIN

INTERIOR DISPLAY FINISH

CIRCLE: BLACK, WHITE, ALMOND

GLASS DOOR FRAME FINISH

CIRCLE: GOLD (STD), SILVER, BLACK

CHOOSE WALK-IN DOOR LOCATION

- AS SHOWN
- RELOCATE AS INDICATED _____

CHOOSE WALK-IN DOOR HINGING

- AS SHOWN
- OPPOSITE AS SHOWN _____

OPTIONS - EQUIPMENT

- INSULATED FLOOR
- MODIFICATIONS TO HEIGHT
- MODIFICATIONS TO SIZE
- 2 TIER SHELVING FOR STORAGE AREA
- ADDITIONAL ENTRANCE DOOR
- 18" X 18" WINDOW IN WALK-IN DOOR
- DECORATIVE FINISH ON 2ND SIDE
- HEATED GLASS DOORS (NON A/C STORES)
- 24" X 60" SIDE VIEWING WINDOW
- LOW AMBIENT CONTROLS (INDOOR UNIT)
- OUTDOORS REMOTE CONDENSING UNIT
- STANDARD COIL IN LIEU OF SURROUND AIR
- BOUQUET RACK WITH 8 VASES
- WIRE IN LIEU OF GLASS DISPLAY SHELVES
- EXTRA DISPLAY SHELF
- FLUORESCENT LIGHT IN STORAGE AREA

OPTIONS - INSTALLATION

- FACTORY AUTHORIZED INSTALLATION
- INDOORS REMOTE CONDENSING UNIT
- OUTDOOR REMOTE INSTALLATION
- CRANE LIFT
- SITE INSPECTION REQUIRED

NOTES:

ALL REQUIRED ELECTRIC INCLUDING FINAL CONNECTIONS TO SRC EQUIPMENT BY OTHERS
10' DRAIN TUBING PROVIDED FOR CONDENSATE WATER. WATER CAN DRAIN INTO BUCKET PROVIDED BY CUSTOMER

SPECIFICATION & LAYOUT SHEET

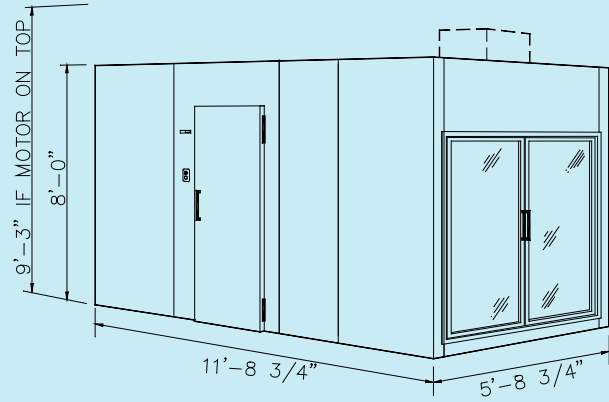

PERSPECTIVE

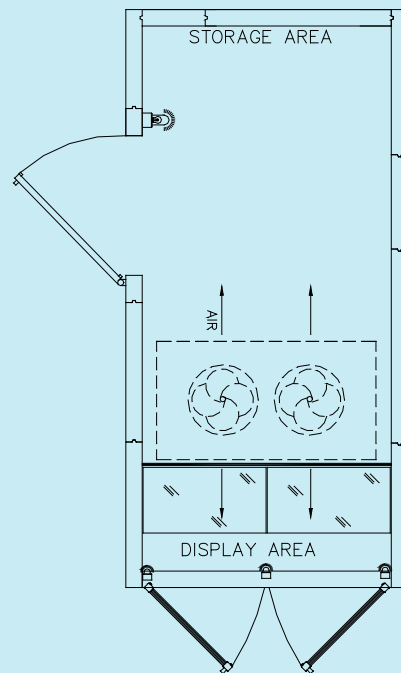

PLAN VIEW